

LRSSR 系列

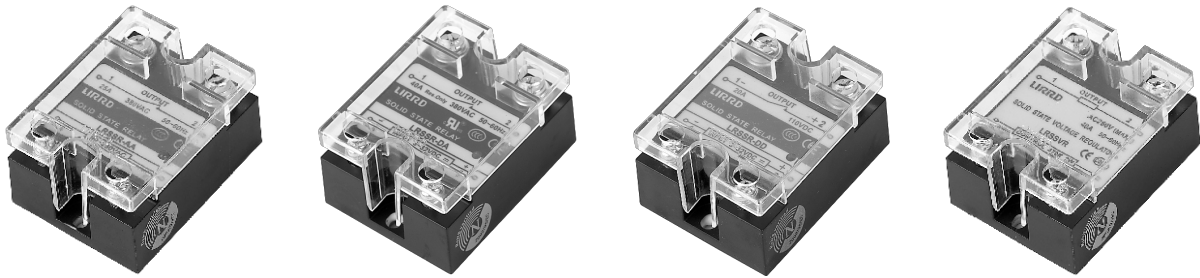

| 类别 | 交流固态系列 | | 直流固态系列 | | | 调压器系列 |
|------------|---------------------------------------|-------------------------|---|-------------------|-----------------|-------------------|
| 产品型号 | LRSSR-AA | LRSSR-DA | LRSSR-DD | | | LRSSVR |
| 负载电压 (V) | 28~285 36~530 | 28~285 36~530 48~660 | 50,100 300,400 | 50,600 | 700,800, 900 | 40~250 80~380 |
| 负载电流 (A) | 5,10,20,30,40,50,60,80,100 | | 5,10,20,30,40, 50,60,80,100 | 5,10,20, 30,40 | 5,10,20, | 5,10,20, 30,40 |
| 介质耐压 (Vac) | 2500 | | | | | |
| 绝缘电阻 (M) | 100 | | | | | |
| 控制电压 (Vdc) | 90-265 | 3-32 | 3-32 | | | |
| 控制电流 (mA) | 10 | 3-35 | 5-20 | | | |
| 通态压降 (V) | 10 | 1.5 | 2.5 | | | |
| 断态漏电流 (mA) | 4 | 2 | 1 | | | |
| 频率范围 (Hz) | 47~63 | | | | | |
| 通断时间 (ms) | 10 | | 0.8 | | | |
| 动作状态指示 | LED | | | | | |
| 环境温度 | -30 +75 | | | | | |
| 安装形式 | 螺栓固定 | | | | | |
| 同类型参照 | SSR,G3NA-420B, LSAP3810A,LSAP2210A | | SSR,JGX-1572F,JGX-1554F, JGX-1598F,JG53FA,JGX-54FA | | | |
| 说明 | 负载电流阻性5A以上, 必须安装散热器 | | | | | |

LRSSR - AA接线图

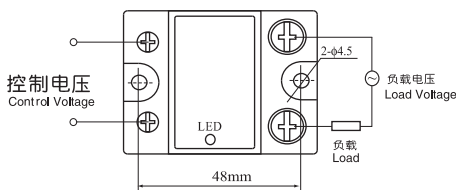

LRSSR - DA接线图

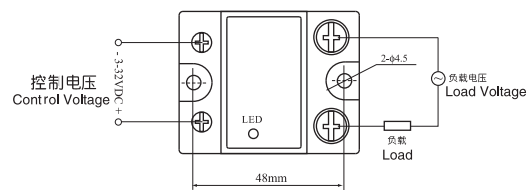

LRSSR - DD接线图

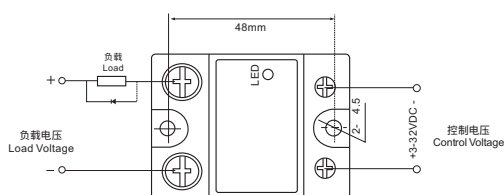

LRSSVR接线图

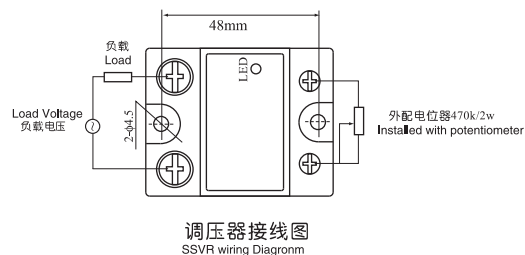

备注：固态与散热器之间必须敷导热硅脂以利散热。
LRSSR 系列外形尺寸和安装尺寸

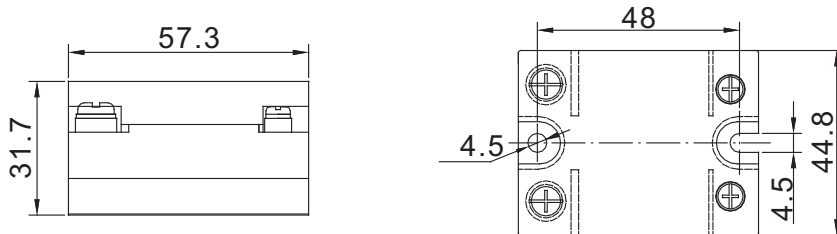

5A~25A配散热器尺寸

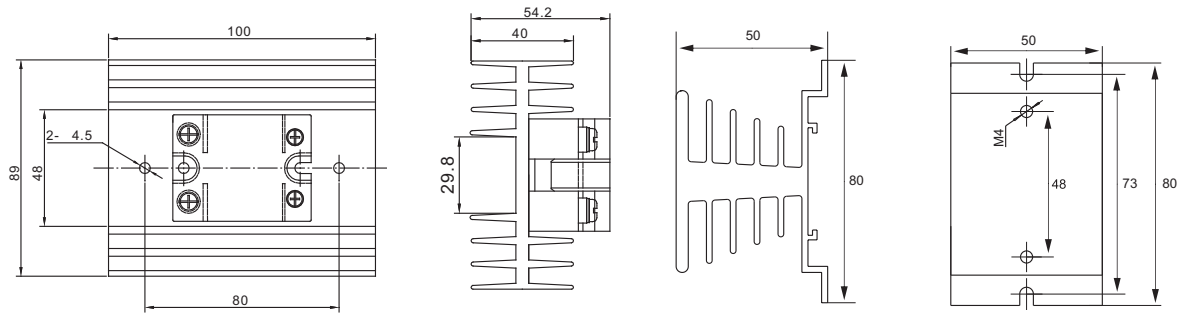

25A~40A配散热器尺寸

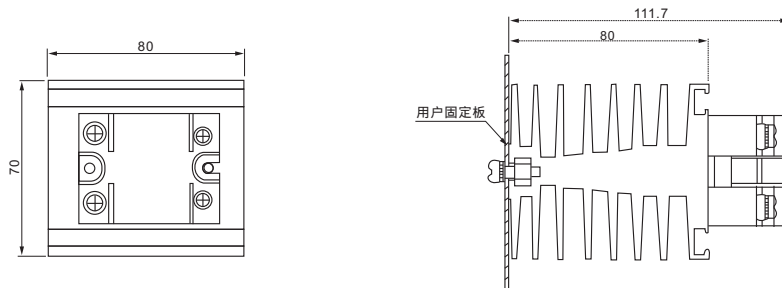

40A~100A配散热器尺寸

